

HAKKIMIZDA

Marmara ve Ege bölgesinde yaygın satış ağına sahip olan ASİSTAL ALÜMİNYUM, 1994 yılından bu yana hizmet vermektedir.

Fabrikamız Kırklareli Organize Sanayi bölgesi içinde yer almakta olup, 44 000 m² lik açık alan üzerinde 19 000 m² lik kapalı alana kuruludur. Son teknolojik gelişmeleri takip eden fabrikamızda 4 inç, 7 inç ve 8 inçlik 3 adet presimiz , eloksal tesisimiz, elektros-tatik toz boyama ünitemiz, ahşap transfer kaplama merkezimiz ile mekanik işleme merkezimiz yer almaktadır. Çevreye duyarlı tesisimizde 15m³/saat kapasiteli (360 m³/gün) kimyasal arıtma ünitemiz ile geri kullanılabilir su elde edilebilmektedir.

ASİSTAL ALÜMİNYUM, balkanlar başta olmak üzere, Avrupa, orta doğu, orta Amerika ülkeleri dahil 30 a yakın ülkeye ihracat yapmaktadır.

Ana satış mağazalarımız Çorlu, Tekirdağ, Edirne, İstanbul, İzmir ve Bulgaristan'ın başkenti Sofya olmak üzere hizmetlerimize devam etmekteyiz.

ABOUT US

Asistal Aluminum having a widespread selling network in the Marmara and Aegean regions, serves since 1994.

Our factory is in the Kırklareli organized industrial zone and established in a closed area of 19 000 m², on an open area of 44 000 m². In our factory, following the recent technological developments, there are 3 presses of 4 inches, 7 inches and 8 inches, eloxal facility, electrostatic powder painting unit, wooden transfer coating center, and mechanical processing center. In our facility, sensitive against the environment, reusable water can be obtained with the chemical treatment unit with a capacity of 15 m³/hour (360 m³/day).

Asistal Aluminum exports near 30 countries, including European, the Middle Eastern, central America, especially to Balkans.

Our main sales stores are in Çorlu, Tekirdağ, Edirne, İstanbul, İzmir, and Sofia, the capital of Bulgaria and we continue our services.

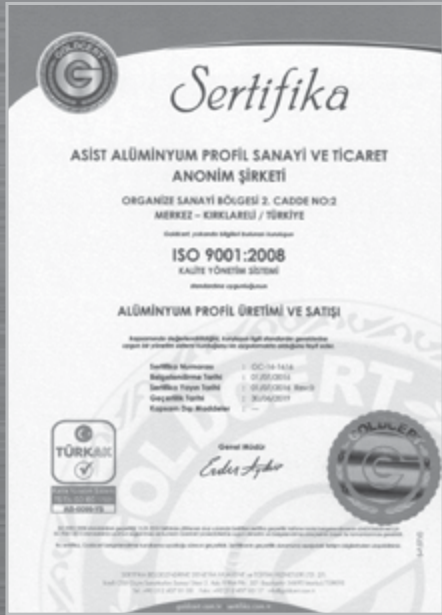

**Authorization
to use the quality sign**



This is to certify that
ASIST ALUMINYUM PROFIL SANAYI VE TICARET A.Ş.

Kirikentli O.S.B. 2. Cadde No:2
TIR - 39100 Kutukdere / Kirikentli

License number: 1638

is authorized to use the quality sign which is shown above according to the REGULATIONS FOR THE USE OF THE QUALANOD QUALITY LABEL FOR SULFURIC ACID-BASED ANODIZING OF ALUMINIUM.

Date of issue of the license: 29.08.2014
Period of validity of the license: valid till 12.2016

Zürich, 12 November 2015

QUALANOD



Thomas Becker
President

CERTIFICATION BODY



Josef Schwegel
AC-Fabrics SA

Mailing address:
QUALANOD, P.O. Box 1007, CH-8007 Zurich
Zürich
QUALANOD via AC-Fabrics SA, Töschstrasse 47, CH-8002 Zurich

Phone: +41 (0)43 300 00 10
Fax: +41 (0)43 300 00 08
E-Mail: info@qualanod.net
Internet: www.qualanod.net

**Authorization
to use the quality sign**



This is to certify that
ASIST ALUMINYUM PROFIL SANAYI VE TICARET A.Ş.

Kirikentli O.S.B. 2. Cadde No:2
TIR - 39100 Kutukdere / Kirikentli

License number: 1432

is authorized to use the quality sign which is shown above according to the REGULATIONS FOR THE USE OF THE QUALICOAT QUALITY SIGN FOR PAINT, LAQUER AND POWDER COATINGS ON ALUMINIUM FOR ARCHITECTURAL APPLICATIONS.

Date of issue of the license: 17.05.2014
Period of validity of the license: valid till 12.2016

Zürich, 17 November 2015

QUALICOAT



Muhammed C. Panam
President

CERTIFICATION BODY



Josef Schwegel
AC-Fabrics SA

Mailing address:
QUALICOAT, P.O. Box 1007, CH-8007 Zurich
Zürich
QUALICOAT via AC-Fabrics SA, Töschstrasse 47, CH-8002 Zurich

Phone: +41 (0)43 300 00 10
Fax: +41 (0)43 300 00 08
E-Mail: info@qualicoat.net
Internet: www.qualicoat.net

TSE TÜRK STANDARLARI ENSTİTÜSÜ
TÜRK STANDARLARINA UYGUNLUK BELGESİ
TURKISH STANDARDS INSTITUTION
CERTIFICATE OF CONFORMITY TO TURKISH STANDARDS

Madde No: Description of the Work
TSE

BELGE NUMARASI CERTIFICATE NUMBER OF LICENSE	16027/156-0011
BELGEİN İLİ VE İLÇESİ TARİHİ DATE OF THIS CERTIFICATE OF LICENSE	09.07.2014
BELGEİN SON GÜNCELLENME TARİHİ DATE OF THE LAST UPDATE	09.07.2017
BELGE SAHADET KURULUĞUN ADI VE İZİNİN KURULUĞU NAME OF THE LICENSING AUTHORITY	ASIST ALUMINYUM PROFİL SANAYİ VE TİCARET ANONİM ŞİRKETİ
BELGE SAHADET KURULUĞUNUN ADRESİ VE İZİNİN KURULUĞU ADDRESS OF THE LICENSING AUTHORITY	KIRIKENTLİ O.S.B.2 CADDESİ NO:2 KUTUKDERE KIRIKENTLİ / TÜRKİYE
ÜRETİM YERİ ADI NAME OF THE MANUFACTURING PLACE	ASIST ALUMINYUM PROFİL SANAYİ VE TİCARET ANONİM ŞİRKETİ
ÜRETİM YERİNİN ADRESİ ADDRESS OF THE MANUFACTURING PLACE	KIRIKENTLİ O.S.B.2 CADDESİ NO:2 KUTUKDERE / TÜRKİYE
İFTAL EDİLEN BELGE NUMARASI (İzinsiz kullanımları engellenmiştir) CERTIFICATE NUMBER OF THE REVOKED LICENSE	1432/14-04/15/156-0011
İFTAL EDİLEN BELGE SAHADET KURULUĞUNUN ADRESİ VE İZİNİN KURULUĞU ADDRESS OF THE LICENSING AUTHORITY	ASIST ALUMINYUM PROFİL SANAYİ VE TİCARET ANONİM ŞİRKETİ
İFTAL EDİLEN BELGE SAHADET KURULUĞUNUN ADRESİ VE İZİNİN KURULUĞU ADDRESS OF THE LICENSING AUTHORITY	TSE EN 10014-1 Alüminyum ve alüminyum alaşımların - Statik ve dinamik yükler altında kullanılması için uygunluk belgesi - Bölüm 3: Profiller - İhtiyaç ve gereklilikler - (09.07.2015)
BELGE SAHADET KURULUĞUNUN ADRESİ VE İZİNİN KURULUĞU ADDRESS OF THE LICENSING AUTHORITY	TSE EN 10014-1 Alüminyum ve alüminyum alaşımların - Statik ve dinamik yükler altında kullanılması için uygunluk belgesi - Bölüm 3: Profiller - İhtiyaç ve gereklilikler - (09.07.2015)

ASIST NURİYE AKINTIL
TSE İSTANBUL BELGELENERNE MÜHÜRÜ

TSE TÜRK STANDARLARI ENSTİTÜSÜ
TÜRK STANDARLARINA UYGUNLUK BELGESİ
TURKISH STANDARDS INSTITUTION
CERTIFICATE OF CONFORMITY TO TURKISH STANDARDS

Madde No: Description of the Work
TSE

BELGE NUMARASI CERTIFICATE NUMBER OF LICENSE	16027/156-0011
BELGEİN İLİ VE İLÇESİ TARİHİ DATE OF THIS CERTIFICATE OF LICENSE	09.07.2014
BELGEİN SON GÜNCELLENME TARİHİ DATE OF THE LAST UPDATE	09.07.2017
BELGE SAHADET KURULUĞUNUN ADRESİ VE İZİNİN KURULUĞU ADDRESS OF THE LICENSING AUTHORITY	ASIST ALUMINYUM PROFİL SANAYİ VE TİCARET ANONİM ŞİRKETİ
BELGE SAHADET KURULUĞUNUN ADRESİ VE İZİNİN KURULUĞU ADDRESS OF THE LICENSING AUTHORITY	KIRIKENTLİ O.S.B.2 CADDESİ NO:2 KUTUKDERE KIRIKENTLİ / TÜRKİYE
ÜRETİM YERİ ADI NAME OF THE MANUFACTURING PLACE	ASIST ALUMINYUM PROFİL SANAYİ VE TİCARET ANONİM ŞİRKETİ
ÜRETİM YERİNİN ADRESİ ADDRESS OF THE MANUFACTURING PLACE	KIRIKENTLİ O.S.B.2 CADDESİ NO:2 KUTUKDERE / TÜRKİYE
İFTAL EDİLEN BELGE NUMARASI (İzinsiz kullanımları engellenmiştir) CERTIFICATE NUMBER OF THE REVOKED LICENSE	1432/14-04/15/156-0011
İFTAL EDİLEN BELGE SAHADET KURULUĞUNUN ADRESİ VE İZİNİN KURULUĞU ADDRESS OF THE LICENSING AUTHORITY	ASIST ALUMINYUM PROFİL SANAYİ VE TİCARET ANONİM ŞİRKETİ
İFTAL EDİLEN BELGE SAHADET KURULUĞUNUN ADRESİ VE İZİNİN KURULUĞU ADDRESS OF THE LICENSING AUTHORITY	TSE EN 10014-1 Alüminyum ve alüminyum alaşımların - Statik ve dinamik yükler altında kullanılması için uygunluk belgesi - Bölüm 3: Profiller - İhtiyaç ve gereklilikler - (09.07.2015)
BELGE SAHADET KURULUĞUNUN ADRESİ VE İZİNİN KURULUĞU ADDRESS OF THE LICENSING AUTHORITY	TSE EN 10014-1 Alüminyum ve alüminyum alaşımların - Statik ve dinamik yükler altında kullanılması için uygunluk belgesi - Bölüm 3: Profiller - İhtiyaç ve gereklilikler - (09.07.2015)

ASIST NURİYE AKINTIL
TSE İSTANBUL BELGELENERNE MÜHÜRÜ

BORU KÜPEŞTE PROFİLLERİ
CIRCULAR RAILING PROFILES

ALASIS
ASIS
ISIT

16'LİK DİKME PROFİL LİSTESİ -PROFILES LIST FOR Ø16 VERTICAL PROFILE

01-000160-10				
16'LİK BORU PROFİL Ø16 TUBE PROFILE	AĞIRLIK / Weight 0,127 kg/mt			
01-000160-13				
16'LİK BORU PROFİL Ø16 TUBE PROFILE	AĞIRLIK / Weight 0,163 kg/mt			
01-000160-15				
16'LİK BORU PROFİL Ø16 TUBE PROFILE	AĞIRLIK / Weight 0,185 kg/mt			
01-000160-20				
16'LİK BORU PROFİL Ø16 TUBE PROFILE	AĞIRLIK / Weight 0,238 kg/mt			
01-000160-40				
16'LİK BORU PROFİL Ø16 TUBE PROFILE	AĞIRLIK / Weight 0,408 kg/mt			
01-000160-50				
16'LİK BORU PROFİL Ø16 TUBE PROFILE	AĞIRLIK / Weight 0,468 kg/mt			
20-160011-20				
16'LİK BORU PROFİL Ø16 TUBE PROFILE	AĞIRLIK / Weight 0,263 kg/mt			

16' LİK DİKME AKSESUAR LİSTESİ - ACCESSORIES LISTS FOR Ø16

AS01-160		AS15-166	
16' LİK BORU FLANŞ Ø16mm TUBE FLANGE		16' LİK TUTAMAK Ø16mm TUBE HOLDER	
AS03-160		AS15-167	
16' LİK DIŞTAN VİDALI FLANŞ Ø16mm TUBE FLANGE-EXTERNAL SCREWED		16' LİK ÇİFTLİ TUTAMAK Ø16mm TUBE DOUBLE HOLDER	
AS06-160		AS15-171	
16' LİK BORU BİLEZİK Ø16mm TUBE RING		16' LİK VİDA TAPASI Ø16mm TUBE SCREWABLE PLUG	
AS10-161		AS16-630	
16' LİK BORU TAPASI Ø16mm TUBE PLUG		16' LİK BORU 30' LUK KURTAĞZI 30mm INTERCONNECTION FOR Ø16mm TUBE	
AS12-160			
16' LİK BORU DEKORLU TAPA Ø16mm TUBE DECORATIVE PLUG			
AS14-161			
16' LİK BORU 90° DİRSEK Ø16mm TUBE 90° ELBOW			
AS14-162			
16' LİK BORU 135° DİRSEK Ø16mm TUBE 135° ELBOW			
AS14-163			
16' LİK DEKORATİF BORU - 920mm Ø16mm TUBE DECORATIVE - 920mm			
AS14-164			
16' LİK AYARLI KÜRE DİRSEK Ø16mm ADJUSTABLE SPHERE ELBOW			
AS15-165			
16' LİK KURTAĞIZLI BORU TUTAMAK Ø16mm TUBE HOLDER			

19-25-30-35 LİK DİKME PROFİL LİSTESİ - PROFILES LIST FOR Ø19-Ø25-Ø30-Ø35 VERTICAL PROFILES

20-400121-11			20-260115-15		
KAPAK PROFİLİ COVER PROFILE	AĞIRLIK / Weight 0,060 kg/mt		DİKME PROFİLİ-26mm VERTICAL PROFILE-26mm	AĞIRLIK / Weight 0,159 kg/mt	
20-300121-11			01-000300-22		
KAPAK PROFİLİ COVER PROFILE	AĞIRLIK / Weight 0,075 kg/mt		BORU PROFİL-30mm TUBE PROFILE-30mm	AĞIRLIK / Weight 0,521 kg/mt	
20-300122-11			01-000300-25		
KAPAK PROFİLİ COVER PROFILE	AĞIRLIK / Weight 0,058 kg/mt		BORU PROFİL-30mm TUBE PROFILE-30mm	AĞIRLIK / Weight 0,585 kg/mt	
20-400121-11			01-000300-30		
KAPAK PROFİLİ COVER PROFILE	AĞIRLIK / Weight 0,060 kg/mt		BORU PROFİL-30mm TUBE PROFILE-30mm	AĞIRLIK / Weight 0,689 kg/mt	
01-000190-10			01-300112-18		
BORU PROFİL-25mm TUBE PROFILE-25mm	AĞIRLIK / Weight 0,153 kg/mt		DİKME PROFİLİ-30mm VERTICAL PROFILE-30mm	AĞIRLIK / Weight 0,553 kg/mt	
01-000190-12			20-300211-15		
BORU PROFİL-25mm TUBE PROFILE-25mm	AĞIRLIK / Weight 0,182 kg/mt		DİKME PROFİLİ-30mm VERTICAL PROFILE-30mm	AĞIRLIK / Weight 0,415 kg/mt	
01-000250-15			20-281231-18		
BORU PROFİL-25mm TUBE PROFILE-25mm	AĞIRLIK / Weight 0,300 kg/mt		DİKME PROFİLİ-30mm VERTICAL PROFILE-30mm	AĞIRLIK / Weight 0,600 kg/mt	
20-251111-15			20-301211-18		
DİKME PROFİLİ-25mm VERTICAL PROFILE-25mm	AĞIRLIK / Weight 0,354 kg/mt		DİKME PROFİLİ-30mm VERTICAL PROFILE-30mm	AĞIRLIK / Weight 0,621 kg/mt	
20-260110-15			01-000350-25		
DİKME PROFİLİ-26mm VERTICAL PROFILE-26mm	AĞIRLIK / Weight 0,395 kg/mt		BORU PROFİL -35mm TUBE PROFILE-35mm	AĞIRLIK / Weight 0,691 kg/mt	
20-260114-15					
DİKME PROFİLİ-26mm VERTICAL PROFILE-26mm	AĞIRLIK / Weight 0,220 kg/mt				

Profil ağırlıklarımız teorik olup; teslim anındaki tartımız geçerlidir.

19-25-30-35 LİK DİKME AKSESUAR LİSTESİ - ACCESSORIES LISTS FOR Ø19-Ø25-Ø30-Ø35 VERTICAL PROFILES

AS06-190		AS02-335	
19'LUK BORU BİLEZİK Ø19mm TUBE RING		35'LİK BORU FLANŞI Ø35mm TUBE FLANGE	
AS10-190		AS05-351	
19'LUK BORU TAPASI Ø19mm TUBE PLUG		(35x50) BORU HAREKETLİ MAFSAL Ø35 TUBE CRESCENT CONNECTION FOR 50mm	
AS03-330		AS10-335	
30'LUK DIŞTAN VİDALI FLANŞ Ø30mm TUBE FLANGE-EXTERNAL SCREWED		35'LİK BORU TAPASI Ø35mm TUBE PLUG	
AS06-330		AS12-335	
30'LUK BORU BİLEZİK Ø30mm TUBE RING		35'LİK BORU DEKORLU TAPA Ø35mm TUBE DECORATIVE PLUG	
AS10-330			
30'LUK BORU TAPASI Ø30mm TUBE PLUG			
AS14-330			
30'LUK AYARLI KÜRE DİRSEK Ø30mm TUBE ADJUSTABLE SPHERE ELBOW			
AS16-630			
(16x30) BORU ARA BAĞLANTI 30mm INTERCONNECTION FOR Ø16mm TUBE			
AS16-330			
(30x30) BORU ARA BAĞLANTI 30mm INTERCONNECTION FOR Ø30mm TUBE			
AS16-340			
(30x40) BORU ARA BAĞLANTI 40mm INTERCONNECTION FOR Ø30mm TUBE			
AS16-355			
(35x50) BORU SABİT MAFSAL 5x0mm INTERCONNECTION FOR Ø35mm TUBE			

40 LİK DİKME PROFİL LİSTESİ - PROFILES LIST FOR Ø40 VERTICAL PROFILES

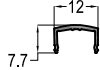
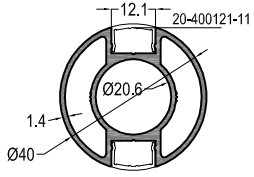
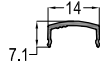
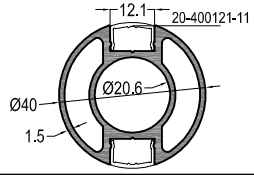
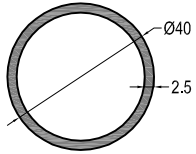
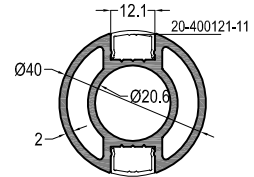
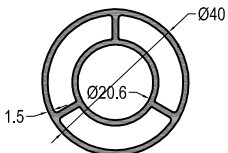
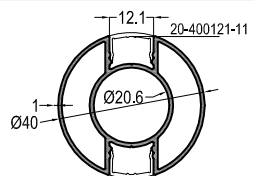
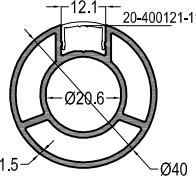
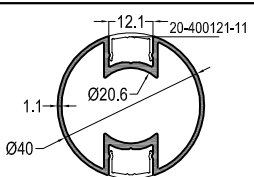
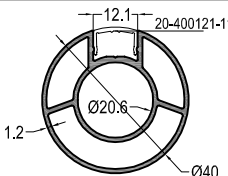
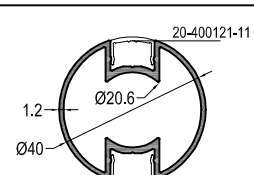
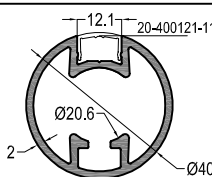
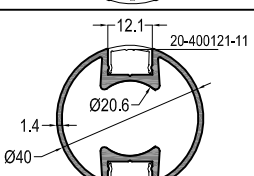
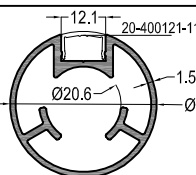
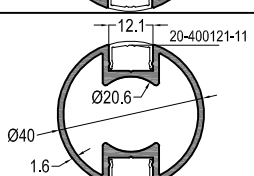
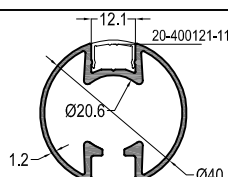
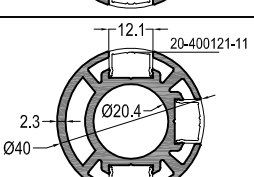
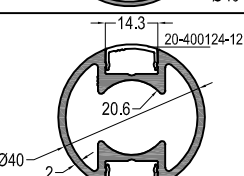
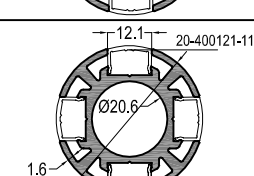
20-400121-11			20-401213-14		
KAPAK PROFİLİ COVER PROFILE	AĞIRLIK / Weight 0,060 kg/mt		DİKME PROFİLİ-40mm VERTICAL PROFILE-40mm	AĞIRLIK / Weight 0,792 kg/mt	
20-400124-12			20-401211-15		
KAPAK PROFİLİ COVER PROFILE	AĞIRLIK / Weight 0,068 kg/mt		DİKME PROFİLİ-40mm VERTICAL PROFILE-40mm	AĞIRLIK / Weight 0,904 kg/mt	
01-000400-25			20-401212-20		
BORU PROFİLİ-40mm TUBE PROFILE-40mm	AĞIRLIK / Weight 0,904 kg/mt		DİKME PROFİLİ-40mm VERTICAL PROFILE-40mm	AĞIRLIK / Weight 1,050 kg/mt	
20-401014-15			20-401211-11		
DİKME PROFİLİ-40mm VERTICAL PROFILE-40mm	AĞIRLIK / Weight 0,865 kg/mt		DİKME PROFİLİ-40mm VERTICAL PROFILE-40mm	AĞIRLIK / Weight 0,583 kg/mt	
20-401216-15			20-402216-11		
DİKME PROFİLİ-40mm VERTICAL PROFILE-40mm	AĞIRLIK / Weight 0,862 kg/mt		DİKME PROFİLİ-40mm VERTICAL PROFILE-40mm	AĞIRLIK / Weight 0,556 kg/mt	
20-401216-12			20-402216-12		
DİKME PROFİLİ-40mm VERTICAL PROFILE-40mm	AĞIRLIK / Weight 0,700 kg/mt		DİKME PROFİLİ-40mm VERTICAL PROFILE-40mm	AĞIRLIK / Weight 0,576 kg/mt	
20-400117-20			20-400216-14		
DİKME PROFİLİ-40mm VERTICAL PROFILE-40mm	AĞIRLIK / Weight 0,882 kg/mt		DİKME PROFİLİ-40mm VERTICAL PROFILE-40mm	AĞIRLIK / Weight 0,692 kg/mt	
20-400111-15			20-400211-16		
DİKME PROFİLİ-40mm VERTICAL PROFILE-40mm	AĞIRLIK / Weight 0,775 kg/mt		DİKME PROFİLİ-40mm VERTICAL PROFILE-40mm	AĞIRLIK / Weight 0,718 kg/mt	
20-400116-12			20-401311-23		
DİKME PROFİLİ-40mm VERTICAL PROFILE-40mm	AĞIRLIK / Weight 0,650 kg/mt		DİKME PROFİLİ-40mm VERTICAL PROFILE-40mm	AĞIRLIK / Weight 1,141 kg/mt	
20-400214-20			20-401411-16		
DİKME PROFİLİ-40mm VERTICAL PROFILE-40mm	AĞIRLIK / Weight 0,896 kg/mt		DİKME PROFİLİ-40mm VERTICAL PROFILE-40mm	AĞIRLIK / Weight 1,071 kg/mt	

Profil ağırlıklarımız teorik olup; teslim anındaki tartımız geçerlidir.

40 LİK DİKME AKSESUAR LİSTESİ - ACCESSORIES LIST FOR Ø40 VERTICAL PROFILES

AS01-440		AS05-451	
40'LIK BORU FLANŞI Ø40mm TUBE FLANGE		(40x50) DİKME HAREKETLİ MAFSAL 50mm CRESCENT CONNECTION FOR Ø40mm	
AS02-440		AS06-440	
40'LIK BORU FLANŞI-TEK TIRNAK Ø40mm TUBE FLANGE-SINGLE PIN		40'LIK BİLEZİK Ø40mm TUBE RING	
AS02-441		AS06-441	
40'LIK BORU FLANŞI-ÇİFT TIRNAK Ø40mm TUBE FLANGE-DOUBLE PINS		40'LIK BORU TAVAN BİLEZİK Ø40mm TUBE CEILING RING	
AS02-442		AS06-442	
40'LIK BORU FLANŞI-TIRNAKSIZ Ø40mm TUBE FLANGE-WITHOUT PIN		40'LIK DİKME ÇİFT TIRNAK TAVAN BİLEZİK Ø40mm TUBE CEILING RING	
AS02-444		AS07-440	
40'LIK DİKME FLANŞI - UZUN Ø40mm TUBE FLANGE - LONG		40'LIK BORUYA GÖRE CAM TUTUCU 12mm Ø40mm TUBE GLASS HOLDER	
AS02-445		AS07-441	
40'LIK DEKORLU ARA FLANŞ Ø40mm TUBE FLANGE-DECORATIVE		40'LIK BORUYA GÖRE VİDALI CAM TUTUCU 12mm Ø40mm TUBE SCREWED GLASS HOLDER	
AS03-440		AS07-442	
40'LIK DIŞTAN VİDALI FLANŞ - KISA Ø40mm TUBE FLANGE-EXTERNAL SCREWED		40'LIK BORUYA GÖRE FİTİLLİ CAM TUTUCU Ø40mm TUBE ADJUSTABLE GLASS HOLDER	
AS03-441		AS08-440	
40'LIK DIŞTAN VİDALI FLANŞ - UZUN Ø40mm TUBE FLANGE-EXTERNAL SCREWED		40'LIK DİKMEYE GÖRE CAM TUTUCU 12mm Ø40mm TUBE GLASS HOLDER	
AS04-440		AS08-441	
40'LIK DIŞTAN VİDALI FLANŞ KAPAĞI Ø40mm TUBE FLANGE COVER-EXTERNAL SCREWED		40'LIK DİKMEYE GÖRE VİDALI CAM TUTUCU 12mm Ø40mm TUBE SCREWED GLASS HOLDER	
AS05-450		AS08-442	
(40x50) BORU HAREKETLİ MAFSAL 50mm CRESCENT CONNECTION FOR Ø40mm		40'LIK DİKMEYE GÖRE FİTİLLİ CAM TUTUCU Ø40mm TUBE ADJUSTABLE GLASS HOLDER	

40 LİK DİKME AKSESUAR LİSTESİ - ACCESSORIES LISTS FOR Ø40 VERTICAL PROFILES

AS08-443		AS16-441	
40'LİK DİKME ARASI CAM TUTUCU Ø40mm TUBE GLASS HOLDER		(40x40) BORU ARA BAĞLANTI 40mm INTERCONNECTION FOR Ø40mm TUBE	
AS08-444		AS16-450	
40'LİK DİKME TEKLİ CAM TUTUCU Ø40mm TUBE SINGLE GLASS HOLDER		(40x50) DİKME ARA BAĞLANTI 50mm INTERCONNECTION FOR Ø40mm TUBE	
AS08-445		AS16-452	
40'LİK DİKME ÇİFTLİ CAM TUTUCU Ø40mm TUBE DOUBLE GLASS HOLDER		(40x50) DİKME SABİT MAFSAL 50mm INTERCONNECTION FOR Ø40mm TUBE	
AS10-440		AS17-330	
40'LİK BORU TAPASI Ø40 TUBE PLUG		40'LİK DUVAR ARA BAĞLANTI Ø40mm TUBE INTERCONNECTION FROM WALL	
AS11-440		AS17-331	
40'LİK DİKME TAPASI Ø40 TUBE PLUG		DUVAR PULU CAPS FOR WALL	
AS12-441			
40'LİK DİKME DEKORLU TAPA Ø40 TUBE DECORATIVE PLUG			
AS12-551			
40'LİK DİKME DEKORLU TAPA Ø50mm TUBE DECORATIVE PLUG			
AS16-340			
(30x40) BORU ARA BAĞLANTI 40mm INTERCONNECTION FOR Ø30mm TUBE			
AS16-350			
(40x50) BORU ARA BAĞLANTI 50mm INTERCONNECTION FOR Ø40mm TUBE			
AS16-440			
(40x40) DİKME ARA BAĞLANTI 40mm INTERCONNECTION FOR Ø40mm TUBE			

50 ve 60 LIK DİKME PROFİL LİSTESİ - PROFILES LIST FOR Ø50-Ø60 VERTICAL PROFILES

20-500021-10			20-210021-15		
KAPAK PROFİLİ COVER PROFILE	AĞIRLIK / Weight 0,140 kg/mt		KAPAK PROFİLİ COVER PROFILE	AĞIRLIK / Weight 0,115 kg/mt	
01-000500-15			20-500051-17		
BORU PROFİL-50mm TUBE PROFILE-50mm	AĞIRLIK / Weight 0,619 kg/mt		ÜST PROFİL-50mm TOP RAIL PROFILE-50mm	AĞIRLIK / Weight 1,163 kg/mt	
01-000500-20			20-501121-20		
BORU PROFİL-50mm TUBE PROFILE-50mm	AĞIRLIK / Weight 0,817 kg/mt		DİKME PROFİLİ-50mm VERTICAL PROFILE-50mm	AĞIRLIK / Weight 1,060 kg/mt	
01-000500-25			01-000600-13		
BORU PROFİL -50mm TUBE PROFILE-50mm	AĞIRLIK / Weight 1,011 kg/mt		BORU PROFİL-60mm TUBE PROFILE-60mm	AĞIRLIK / Weight 0,648 kg/mt	
20-501113-20			01-000600-15		
DİKME PROFİLİ-50mm VERTICAL PROFILE-50mm	AĞIRLIK / Weight 1,366 kg/mt		BORU PROFİL-60mm TUBE PROFILE-60mm	AĞIRLIK / Weight 0,745 kg/mt	
20-501311-25			01-000600-25		
DİKME PROFİLİ-50mm VERTICAL PROFILE-50mm	AĞIRLIK / Weight 1,652 kg/mt		BORU PROFİL-60mm TUBE PROFILE-60mm	AĞIRLIK / Weight 1,220 kg/mt	
20-500132-25			01-100660-30		
DİKME PROFİLİ-50mm VERTICAL PROFILE-50mm	AĞIRLIK / Weight 1,282 kg/mt		BORU PROFİL-66mm TUBE PROFILE-66mm	AĞIRLIK / Weight 1,380 kg/mt	

Profil ağırlıklarımız teorik olup; teslim anındaki tartımız geçerlidir.

50 ve 60 LİK DİKME AKSESUAR LİSTESİ - ACCESSORIES LIST FOR Ø50-Ø60 VERTICAL PROFILES

AS01-550		AS05-550	
50'LİK BORU FLANŞI Ø50mm TUBE FLANGE		(50x50) BORU HAREKETLİ MAFSAL 50mm CRESCENT CONNECTION FOR Ø50mm	
AS01-551		AS06-550	
50'LİK BORU FLANŞI - UZUN Ø50mm TUBE FLANGE - LONG		50'LİK BİLEZİK Ø50mm TUBE RING	
AS03-550		AS06-551	
50'LİK DIŞTAN VİDALI FLANŞ Ø50mm TUBE FLANGE-EXTERNAL SCREWED		50'LİK BİLEZİK - UZUN Ø50mm TUBE RING - LONG	
AS03-551		AS06-552	
50'LİK DIŞTAN VİDALI FLANŞ - UZUN Ø50mm TUBE FLANGE-EXTERNAL SCREWED		50'LİK BORU TAVAN BİLEZİK Ø50mm TUBE CEILING RING	
AS04-550		AS10-550	
50'LİK DIŞTAN VİDALI FLANŞ KAPAĞI Ø50mm TUBE FLANGE COVER-EXTERNAL SCREWED		50'LİK BORU TAPASI Ø50mm TUBE PLUG	
AS05-502		AS12-550	
50'LİK L BAĞLANTI - 135° Ø50mm TUBE ANGLED L CONNECTION		50'LİK BORU DEKORLU TAPA Ø50mm TUBE DECORATIVE PLUG	
AS05-503		AS12-552	
50'LİK L BAĞLANTI - 90° Ø50mm TUBE L CONNECTION		50'LİK BORU KRİSTAL DEKORLU TAPA Ø50mm TUBE DECORATIVE CRYSTAL PLUG	
AS05-351		AS13-554	
(35x50) BORU HAREKETLİ BAĞLANTI 50mm CRESCENT CONNECTION FOR Ø35mm		50'LİK 1/4 BİLEZİKLİ BOŞ DİRSEK Ø50mm TUBE 1/4 EMPTY RING	
AS05-450		AS13-555	
(40x50) BORU HAREKETLİ MAFSAL 50mm CRESCENT CONNECTION FOR Ø40mm		50'LİK 1/8 BİLEZİKLİ BOŞ DİRSEK Ø50mm TUBE 1/8 EMPTY RING	
AS05-451		AS14-551	
(40x50) DİKME HAREKETLİ MAFSAL 50mm CRESCENT CONNECTION FOR Ø40mm		50'LİK BİLEZİKLİ KÜRE DİRSEK-DOLU Ø50mm TUBE SPHERE ELBOW WITH RING	

50 ve 60 LİK DİKME AKSESUAR LİSTESİ - ACCESSORIES LIST FOR Ø50-Ø60 VERTICAL PROFILES

AS14-550		AS12-661	
50'LİK BİLEZİKLİ KÜRE DİRSEK-BOŞ Ø50mm TUBE SPHERE ELBOW WITH RING		60'LİK BORU DEKORLU KRİSTAL TAPA Ø60mm TUBE DECORATIVE CRYSTAL PLUG	
AS14-552		AS16-350	
50'LİK FRANSIZ BALKON KÜRE Ø50mm TUBE SPHERE FOR FRENCH BALCONY		(40x50) BORU ARA BAĞLANTI 50mm INTERCONNECTION FOR Ø40mm TUBE	
AS14-553		AS16-355	
50'LİK SABİT MAFSALLI KÜRE DİRSEK Ø50mm TUBE SPHERE ELBOW		(35x50) BORU ARA BAĞLANTI 50mm INTERCONNECTION FOR Ø35mm TUBE	
AS17-550		AS16-450	
50'LİK DEKORLU TAPA BAĞLANTISI Ø50mm TUBE DECORATIVE PLUG CONNECTION		(40x50) DİKME ARA BAĞLANTI 50mm INTERCONNECTION FOR Ø40mm TUBE	
AS17-551		AS16-550	
50'LİK BORU DUVAR DİBİ BAĞLANTI Ø50mm TUBE WALL CONNECTION		(50x50) BORU ARA BAĞLANTI 50mm INTERCONNECTION FOR Ø50mm TUBE	
AS01-660			
60'LİK BORU FLANŞI Ø60mm TUBE FLANGE			
AS03-660			
60'LİK DIŞTAN VİDALI FLANŞ Ø60mm TUBE FLANGE-EXTERNAL SCREWED			
AS06-660			
60'LİK BORU BİLEZİK Ø60mm TUBE RING			
AS10-660			
60'LİK BORU TAPASI Ø60mm TUBE PLUG			
AS12-660			
60'LİK BORU TAPA Ø60mm TUBE DECORATIVE PLUG			

GENEL KÜPEŞTE AKSESUAR VE ANKRAJ LİSTESİ - ACCESSORIES LISTS FOR GENERAL & ANCHORS

AS09-400		AS18-440	
CAM TAKOZU GLASS STOPER		40'LIK DİKME ANKRAJ DEMİRİ DOLU 140mm Ø40mm TUBE ANCHOR - 140mm	
AS09-400P		AS18-441	
CAM TAKOZU - PLASTİK GLASS STOPER		40'LIK DİKME ANKRAJ DEMİRİ DOLU 210mm Ø40mm TUBE ANCHOR - 210mm	
AS17-441		AS18-442	
40'LIK DİKME YAN BAĞLANTI-KUMBARA SPECIAL INTERCONNECTION		40'LIK DİKME ANKRAJ DEMİRİ - 240mm Ø40mm TUBE ANCHOR - 240mm	
AS17-230		AS18-443	
PERDE ASKISI TEKLİ SINGLE BLIND HANGER		40'LIK DİKME ANKRAJ DEMİRİ - 480mm Ø40mm TUBE ANCHOR - 480mm	
AS17-225		AS18-444	
PERDE ASKISI ÇİFTLİ DOUBLE BLIND HANGER		40'LIK DİKME VİDALI ANKRAJ - 210mm Ø40mm TUBE SCREWED ANCHOR - 210mm	
AS19-150		AS18-445	
KÜPEŞTE KAPI MENTEŞESİ DOOR HINGE		40'LIK DİKME YANDAN ANKRAJ DEMİRİ Ø40mm TUBE ANCHOR FROM SIDE	
AS19-200			
KÜPEŞTE KAPI SÜRGÜSÜ DOOR BOLT			

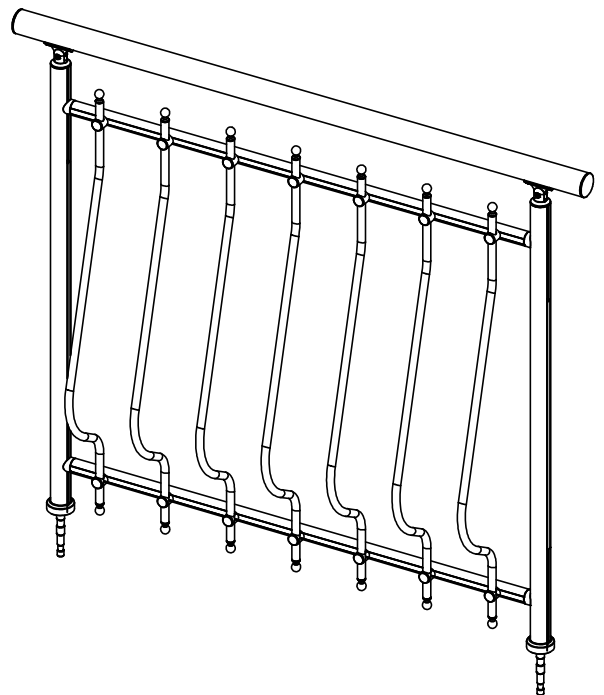
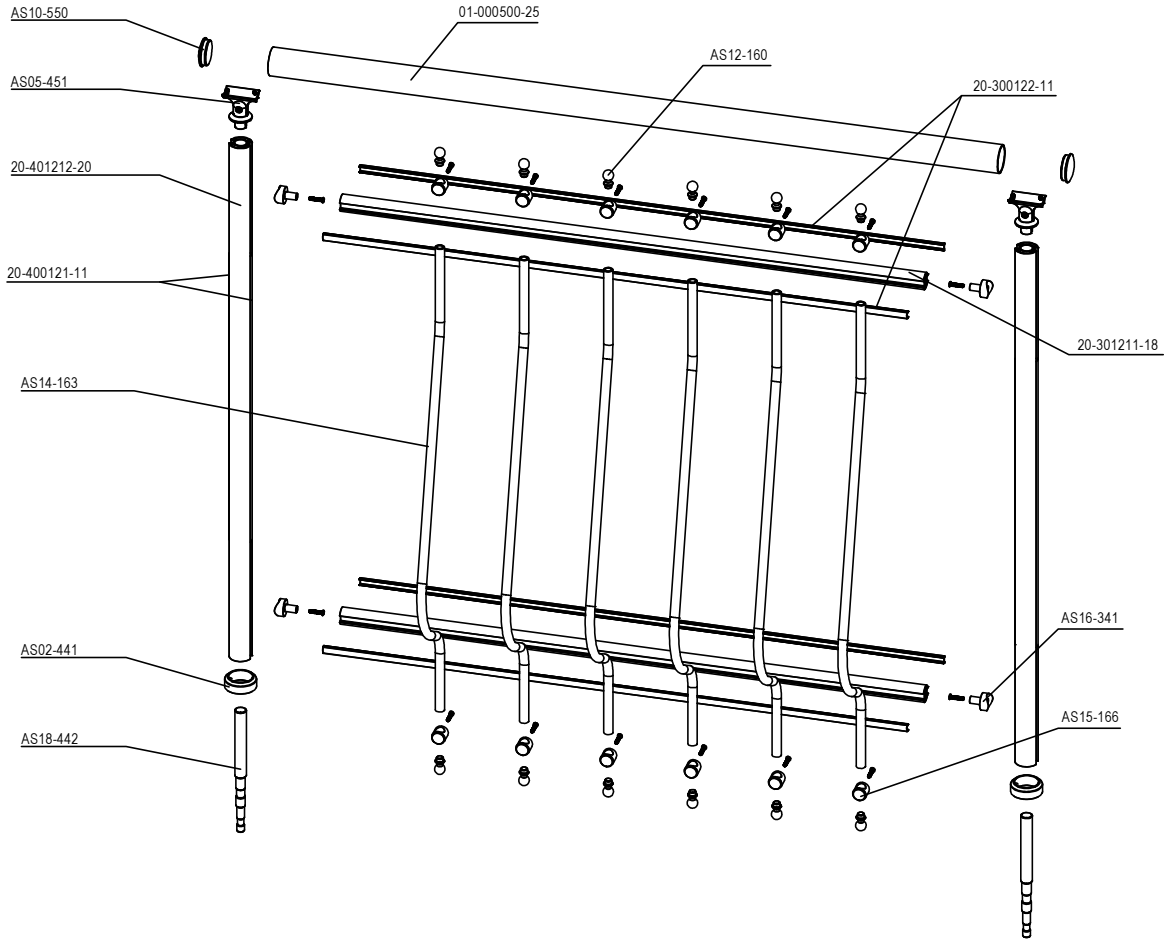

KARE KÜPEŞTE PROFİLLERİ
SQUARE RAILING PROFILES



PROFİL LİSTESİ - PROFILE LISTS

20-3202			20-3102		
KÜPEŞTE ÜST PROFİLİ UPPER RAILING PROFILE	AĞIRLIK / Weight 0,780 kg/mt		DİKME PROFİLİ VERTICAL PROFILE	AĞIRLIK / Weight 1,130 kg/mt	
20-3203					
KÜPEŞTE ÜST PROFİLİ UPPER RAILING PROFILE	AĞIRLIK / Weight 0,850 kg/mt				
20-601032-25			20-3103		
KÜPEŞTE ÜST PROFİLİ UPPER RAILING PROFILE	AĞIRLIK / Weight 1,060 kg/mt		DİKME PROFİLİ VERTICAL PROFILE	AĞIRLIK / Weight 1,150 kg/mt	
20-3204					
KÜPEŞTE ÜST PROFİLİ UPPER RAILING PROFILE	AĞIRLIK / Weight 1,310 kg/mt				
20-3201			20-3104		
KÜPEŞTE ÜST PROFİLİ UPPER RAILING PROFILE	AĞIRLIK / Weight 1,110 kg/mt		DİKME PROFİLİ VERTICAL PROFILE	AĞIRLIK / Weight 0,900 kg/mt	
20-800021-18					
KÜPEŞTE ÜST PROFİLİ UPPER RAILING PROFILE	AĞIRLIK / Weight 1,230 kg/mt				
20-756001-16			20-501112-15		
DİKME PROFİLİ VERTICAL PROFILE	AĞIRLIK / Weight 1,370 kg/mt		DİKME PROFİLİ VERTICAL PROFILE	AĞIRLIK / Weight 0,990 kg/mt	
20-3101					
DİKME PROFİLİ VERTICAL PROFILE	AĞIRLIK / Weight 1,140 kg/mt				



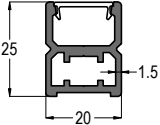
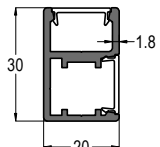
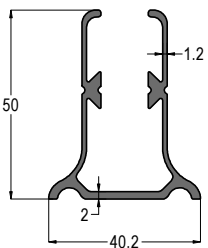
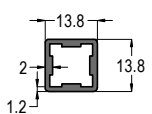
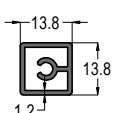
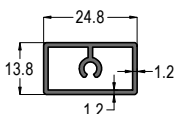
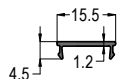
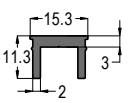









PROFİL LİSTESİ - PROFILE LISTS

20-3405				
PANEL PROFİLİ PANEL PROFILE	AĞIRLIK / Weight 0,470 kg/mt			
20-3404				
PANEL PROFİLİ PANEL PROFILE	AĞIRLIK / Weight 0,850 kg/mt			
20-2401				
PANEL PROFİLİ PANEL PROFILE	AĞIRLIK / Weight 0,724 kg/mt			
20-3401				
YATAY VE DÜŞEY EMNİYET PROFİLİ HORIZONTAL & VERTICAL INFILL PROFILE	AĞIRLIK / Weight 0,215 kg/mt			
20-3402				
YATAY VE DÜŞEY EMNİYET PROFİLİ HORIZONTAL & VERTICAL INFILL PROFILE	AĞIRLIK / Weight 0,220 kg/mt			
20-3403				
YATAY VE DÜŞEY EMNİYET PROFİLİ HORIZONTAL & VERTICAL INFILL PROFILE	AĞIRLIK / Weight 0,300 kg/mt			
20-806021-12				
KAPAK PROFİLİ COVER PROFILE	AĞIRLIK / Weight 0,063 kg/mt			
20-3501				
KAPAK PROFİLİ COVER PROFILE	AĞIRLIK / Weight 0,220 kg/mt			













AKSESUAR LİSTESİ - ACCESSORIES LIST

AS-EM 111		20-3202 20-3204	AS-EM 221		20-3202 20-3204
MAFSAL BRACKET			MAFSAL BRACKET	20-3104	
AS-EM 112		20-3202 20-3204	AS-EM 231		20-3201 20-3202 20-3203 20-3204
MAFSAL BRACKET			MAFSAL BRACKET	20-3104	
AS-EM 211		20-3201 20-3202 20-3203 20-3204	AS-EM 232		20-3202 20-3204
MAFSAL BRACKET	20-3101 20-3102 20-3103		MAFSAL BRACKET	20-501112-15	
AS-EM 212		20-3202 20-3204	AS-EM 233		20-3202 20-3204
MAFSAL BRACKET	20-3101 20-3102 20-3103		MAFSAL BRACKET	20-501112-15	
AS-EM 213		20-3202 20-3204			
MAFSAL BRACKET	20-3101 20-3102 20-3103				
AS-EM 214		20-3202 20-3203			
MAFSAL BRACKET	20-3101 20-3102 20-3103				
AS-EM 214A		20-3202			
MAFSAL BRACKET	20-3101 20-3102 20-3103				
AS-EM 215		20-3201 20-3204			
MAFSAL BRACKET	20-3101 20-3102 20-3103				
AS-EM 215A		20-3201 20-3204			
MAFSAL BRACKET	20-3101 20-3102 20-3103				
AS-EM 221		20-3201 20-3202 20-3203 20-3204			
MAFSAL BRACKET	20-3104				

AKSESUAR LİSTESİ - ACCESSORIES LIST

AS-ET 111		20-3202 20-3203	AS-EC 411A	
TAPA PLUG			CAM TUTUCU GLASS HOLDER	20-3101 20-3102 20-3103
AS-ET 112		20-601032-25	AS-EC 411B	
TAPA PLUG			CAM TUTUCU GLASS HOLDER	20-3101 20-3102 20-3103
AS-ET 121		20-3201 20-3204 20-800021-18	AS-EC 412	
TAPA PLUG			CAM TUTUCU GLASS HOLDER	20-3101 20-3102 20-3103 20-3104 20-501112-15
AS-ET 201		20-756001-16	AS-EC 413	
TAPA PLUG			CAM TUTUCU GLASS HOLDER	20-3101 20-3102 20-3103 20-3104 20-501112-15
AS-ET 211		20-3101 20-3102 20-3103		
TAPA PLUG				
AS-ET 221		20-3104		
TAPA PLUG				
AS-ET 231		20-501112-15		
TAPA PLUG				
AS-ET 311		20-3405		
TAPA PLUG				
AS-ET 321		20-3404		
TAPA PLUG				
AS-ET 411		20-3401		
TAPA PLUG				

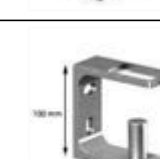
AKSESUAR LİSTESİ - ACCESSORIES LIST

AS-EY 211 YAN BAĞLANTI PAPUCU SIDE INSTALLATION BRACKETS	 20-3101 20-3102 20-3103	AS-EY 312 YAN BAĞLANTI PAPUCU SIDE INSTALLATION BRACKETS	 20-3101 20-3102 20-3103 20-3104 20-501112-15 20-3405
AS-EY 211A YAN BAĞLANTI PAPUCU SIDE INSTALLATION BRACKETS	 20-3101 20-3102 20-3103	AS-EY 411 YAN BAĞLANTI PAPUCU SIDE INSTALLATION BRACKETS	 20-3101 20-3102 20-3103 20-3104 20-501112-15 20-3401
AS-EY 211B YAN BAĞLANTI PAPUCU SIDE INSTALLATION BRACKETS	 20-3101 20-3102 20-3103		
AS-EY 221 YAN BAĞLANTI PAPUCU SIDE INSTALLATION BRACKETS	 20-3104		
AS-EY 221A YAN BAĞLANTI PAPUCU SIDE INSTALLATION BRACKETS	 20-3104		
AS-EY 221B YAN BAĞLANTI PAPUCU SIDE INSTALLATION BRACKETS	 20-3104		
AS-EY 231 YAN BAĞLANTI PAPUCU SIDE INSTALLATION BRACKETS	 20-501112-15		
AS-EY 231A YAN BAĞLANTI PAPUCU SIDE INSTALLATION BRACKETS	 20-501112-15		
AS-EY 231B YAN BAĞLANTI PAPUCU SIDE INSTALLATION BRACKETS	 20-501112-15		
AS-EY 311 YAN BAĞLANTI PAPUCU SIDE INSTALLATION BRACKETS	 20-3101 20-3102 20-3103 20-3104 20-501112-15 20-3405		

AKSESUAR LİSTESİ - ACCESSORIES LIST

AS-EF 111		20-3202 20-3203 20-601032-25	AS-EF 222	
FLANŞ FLANGE			FLANŞ FLANGE	20-3104
AS-EF 112		20-3202	AS-EF 231	
FLANŞ FLANGE		0-40°	FLANŞ FLANGE	20-501112-15
AS-EF 113		20-601032-25	AS-EF 232	
FLANŞ FLANGE			FLANŞ FLANGE	20-501112-15
AS-EF 121		20-3201 20-3204 20-800021-18		
FLANŞ FLANGE				
AS-EF 122		20-3204		
FLANŞ FLANGE		0-40°		
AS-EF 123		20-800021-18		
FLANŞ FLANGE				
AS-EF 201				
FLANŞ FLANGE	20-756001-16			
AS-EF 211		20-3101 20-3102 20-3103		
FLANŞ FLANGE				
AS-EF 212		20-3101 20-3102 20-3103		
FLANŞ FLANGE				
AS-EF 221				
FLANŞ FLANGE	20-3104			













AKSESUAR LİSTESİ - ACCESSORIES LIST

AS-ES 111	 20-3202 20-3203 90°	AS-ES 113B	 20-3202 0-90° + 0-40°
DİRSEK ELBOW		DİRSEK ELBOW	
AS-ES 111A	 20-601032-25 90°	AS-ES 113C	 20-3202 0-40° + 0-90° + 0-40°
DİRSEK ELBOW		DİRSEK ELBOW	
AS-ES 111B	 20-3203 90°	AS-ES 121	 20-3201 20-3204 90°
DİRSEK ELBOW		DİRSEK ELBOW	
AS-ES 111C	 20-3203 90°	AS-ES 121A	 20-800021-18 90°
DİRSEK ELBOW		DİRSEK ELBOW	
AS-ES 112	 20-3202 20-3203 45°	AS-ES 121B	 20-3201 90°
DİRSEK ELBOW		DİRSEK ELBOW	
AS-ES 112A	 20-601032-25 45°	AS-ES 121C	 20-3201 90°
DİRSEK ELBOW		DİRSEK ELBOW	
AS-ES 112B	 20-3203 45°	AS-ES 122	 20-3201 20-3204 45°
DİRSEK ELBOW		DİRSEK ELBOW	
AS-ES 112C	 20-3203 45°	AS-ES 122A	 20-800021-18 45°
DİRSEK ELBOW		DİRSEK ELBOW	
AS-ES 113	 20-3202 0-90°	AS-ES 122B	 20-3201 45°
DİRSEK ELBOW		DİRSEK ELBOW	
AS-ES 113A	 20-3202 0-40°	AS-ES 122C	 20-3201 45°
DİRSEK ELBOW		DİRSEK ELBOW	









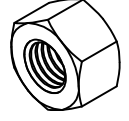

AKSESUAR LİSTESİ - ACCESSORIES LIST

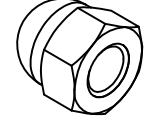
AS-ES 123		20-3201 20-3204	AS-ES 413		20-3401
DİRSEK ELBOW		0-90°	DİRSEK ELBOW		0-90°
AS-ES 123A		20-3204	AS-ES 413A		20-3401
DİRSEK ELBOW		0-40°	DİRSEK ELBOW		90° + 0-90°
AS-ES 123BL		20-3204			
DİRSEK ELBOW		90° + 0-40°			
AS-ES 123BR		20-3204			
DİRSEK ELBOW		0-40° + 90°			
AS-ES 123C		20-3204			
DİRSEK ELBOW		0-40° + 90° + 0-40°			
AS-ES 311		20-3405			
DİRSEK ELBOW		0-90°			
AS-ES 311		20-3404			
DİRSEK ELBOW		0-90°			
AS-ES 411		20-3401			
DİRSEK ELBOW		90°			
AS-ES 412		20-3401			
DİRSEK ELBOW		45°			
AS-ES 412A		20-3401			
DİRSEK ELBOW		30°			

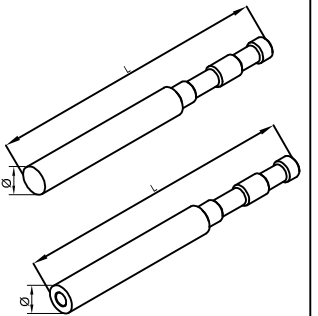
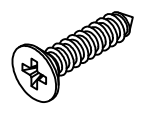
AKSESUAR LİSTESİ - ACCESSORIES LIST

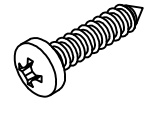
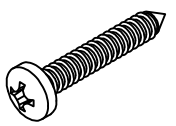
AS-EB 111		20-3202 20-3203	AS-EB 411		20-3401
BİLEZİK RING			BİLEZİK RING		
AS-EB 111A		20-601032-25	AS-EB 412		20-3401
BİLEZİK RING			BAĞLANTI JOINTER		
AS-EB 111B		20-3203			
BİLEZİK RING					
AS-EB 112		20-3202			
BAĞLANTI JOINTER					
AS-EB 113		20-3201 20-3202 20-3203 20-3204			
BAĞLANTI JOINTER					
AS-EB 121		20-3201 20-3204			
BİLEZİK RING					
AS-EB 121A		20-800021-18			
BİLEZİK RING					
AS-EB 121B		20-3201			
BİLEZİK RING					
AS-EB 312		20-3405			
BAĞLANTI JOINTER					
AS-EB 322		20-3404			
BAĞLANTI JOINTER					

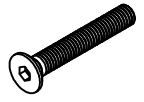
AKSESUAR LİSTESİ - ACCESSORIES LIST

AS-EV 301		SOMUNLAR	
FİTİL GASKET		AS-EA 201 : M8 AS-EA 202 : M10	
AS-EV 302		AS-EA 206	
FİTİL GASKET		KÖR SOMUN BLIND NUT	
AS-EV 303		ANKRAJLAR	
FİTİL GASKET		AS-EA 301 : Ø20 x 350mm *AS-EA 301X : Ø20 x 350mm AS-EA 301A : Ø20 x 230mm AS-EA 301B : Ø20 x 200mm AS-EA 301D : Ø20 40mm **AS-EA 301E : Ø20 x 220mm *Üst kısım M8 dişli / with M8 thread on top **Borudan üretilmiştir / produced from pipe	
AS-EV 304			
FİTİL GASKET			
YHB VİDALAR		AS-EPO 001	
YHB 4,2x19 YHB 4,2 x 38 YHB 4,2 x 45		EPOKSI YAPIŞTIRICI EPOXY GLUE	
YSB VİDALAR		AS-EPG	
YSB 4,2 x 19 YSB 4,2 x 25 YSB 4,2 x 38 YSB 4,2 x 45		EPOKSI TABANCASI GUN FOR EPOXY GLUE	
AS-EV 501		AS-MSA-02	
BULDEKS VİDA -7,5 x100 BULDEX SCREWS		DOĞAL TAŞ YAPIŞTIRICI GLUE FOR STONE	
AS-EV 401			
PASLANMAZ İMBUS CİVATA - M6 x 40 HEXAGONAL SOCKET SCREWS			
İMBUS CİVATALAR			
AS-EV 411 : M6 x60 AS-EV 412 : M6 x 45 AS-EV 413 : M6 x 50			
SAPLAMALAR			
AS-EA 101 : M8 x 140 AS-EA 102 : M8 x 1000 AS-EA 103 : M10 x1250 AS-EA 104 : M10 x 150			

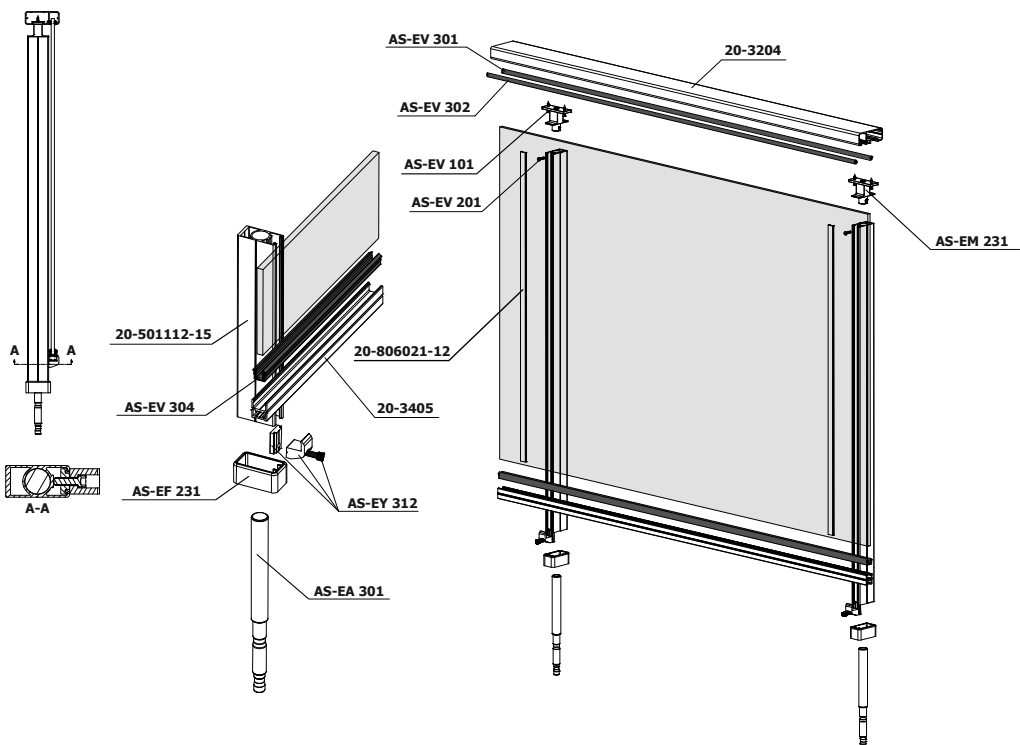
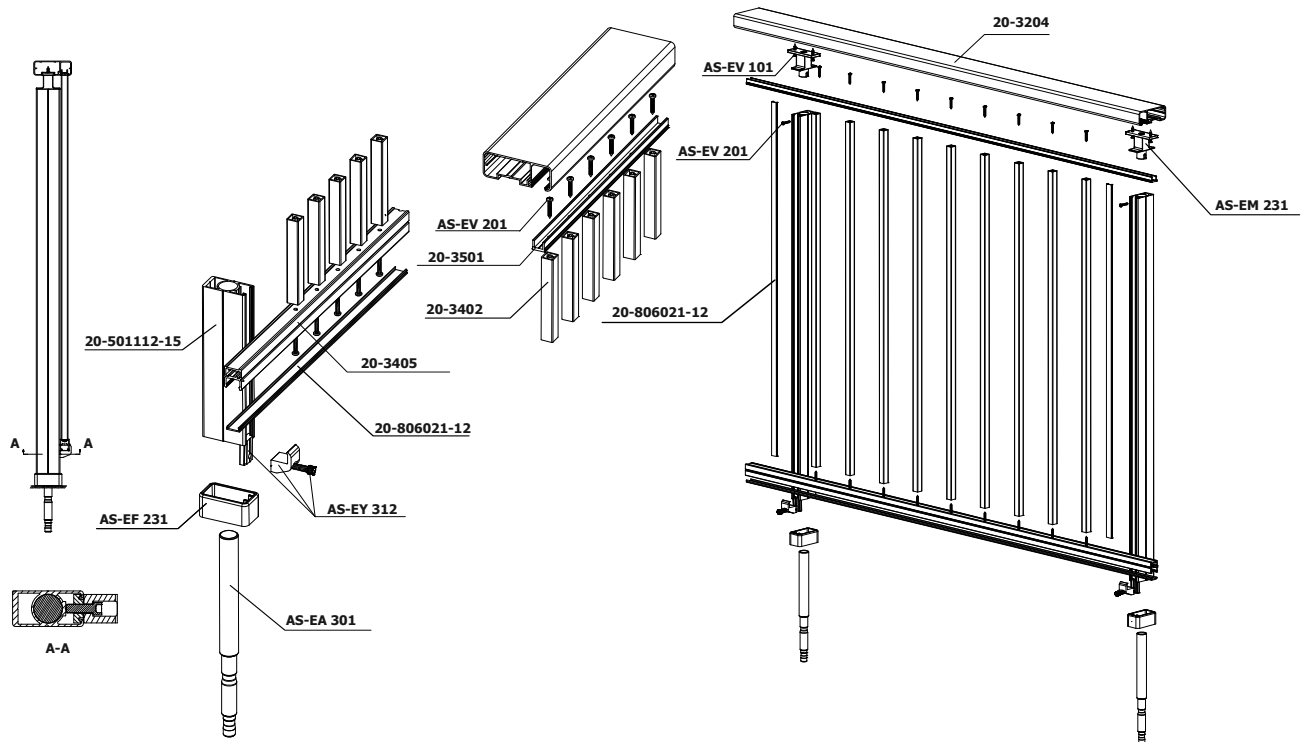

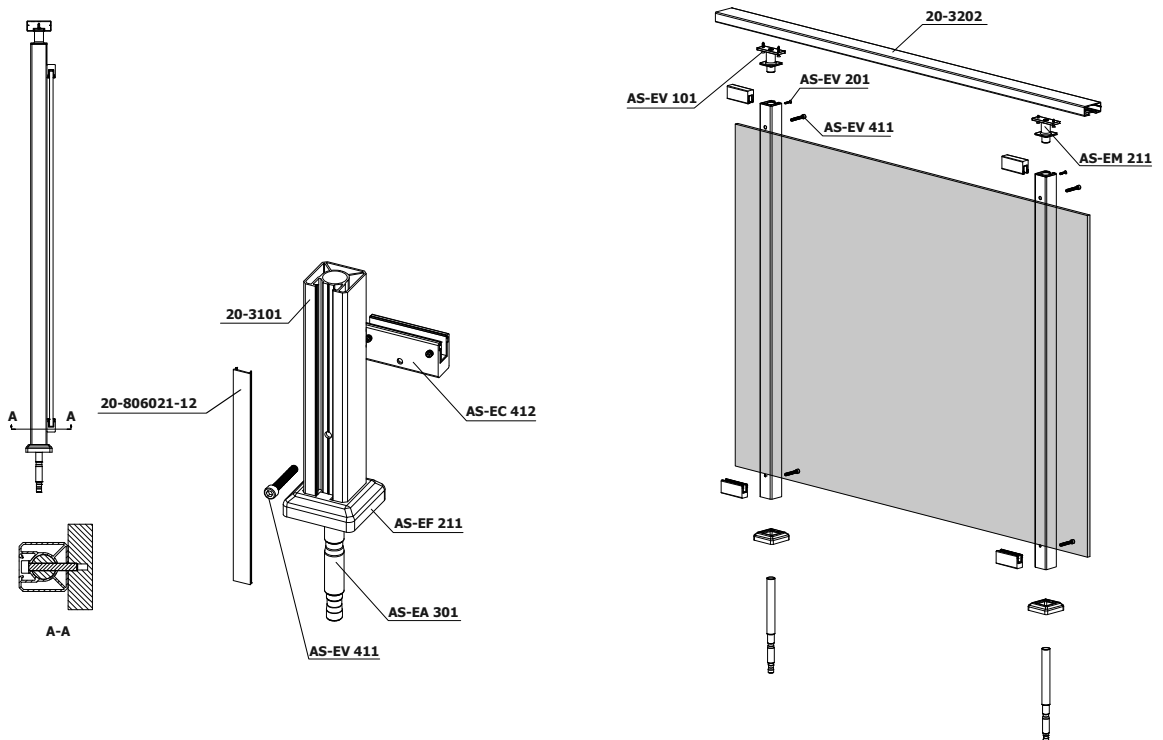
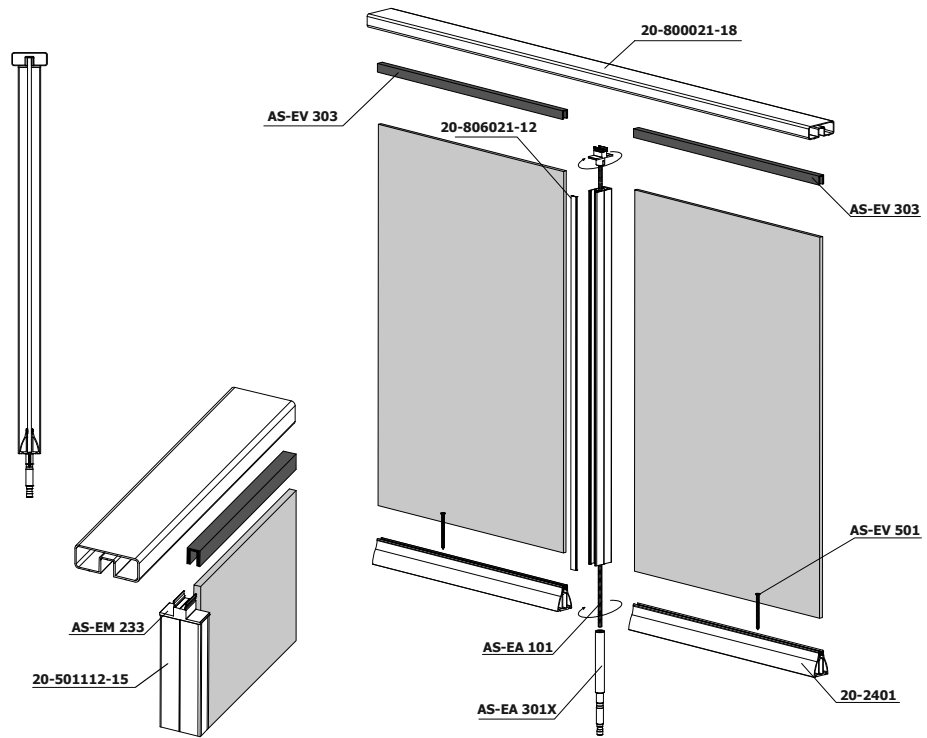

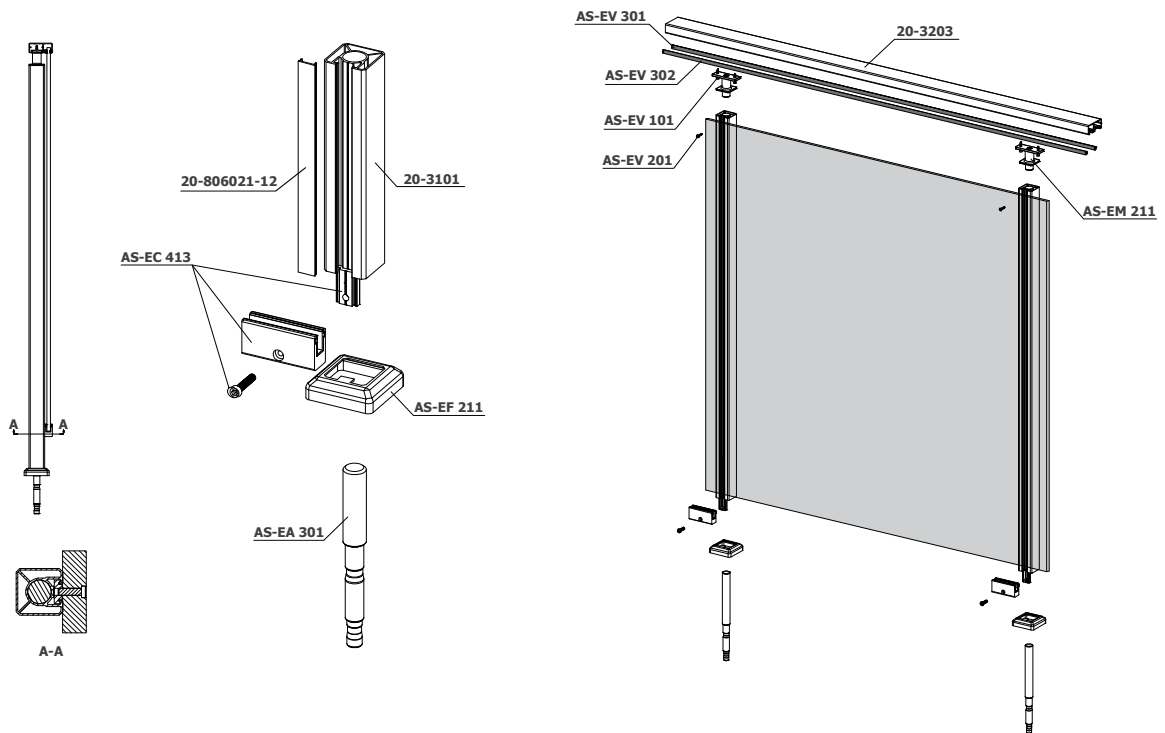
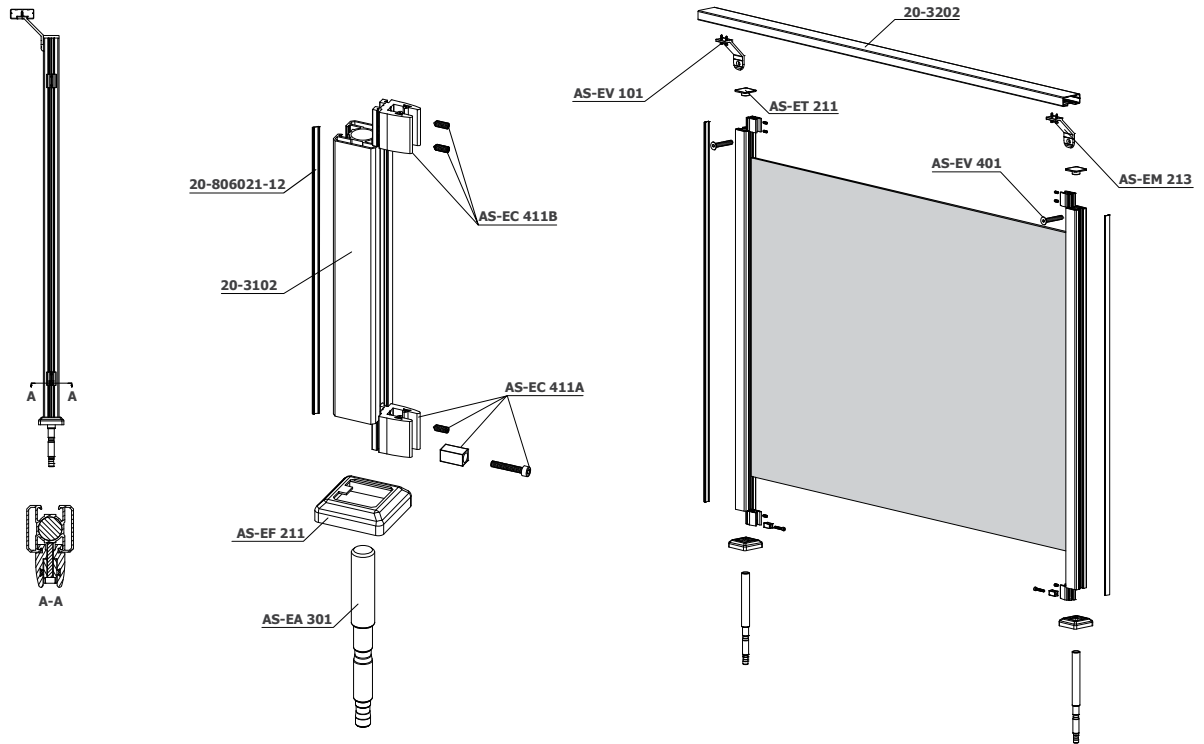

CAM KÜPEŞTE PROFİLLERİ
GLASS RAILING PROFILES

ALASIS
ASIS
ISIT

PROFİL LİSTESİ - PROFILE LISTS

<p>20-730141-32</p> <table border="1"> <tr> <td>CAM TUTUCU PROFİL GLASS HOLDER PROFILE</td> <td>AĞIRLIK / Weight 1,917 kg/mt</td> </tr> </table>	CAM TUTUCU PROFİL GLASS HOLDER PROFILE	AĞIRLIK / Weight 1,917 kg/mt		<p>13-09021</p> <table border="1"> <tr> <td>KÜPEŞTE ÜST PROFİL TOP RAILING PROFILE</td> <td>AĞIRLIK / Weight 1,655 kg/mt</td> </tr> </table>	KÜPEŞTE ÜST PROFİL TOP RAILING PROFILE	AĞIRLIK / Weight 1,655 kg/mt	
CAM TUTUCU PROFİL GLASS HOLDER PROFILE	AĞIRLIK / Weight 1,917 kg/mt						
KÜPEŞTE ÜST PROFİL TOP RAILING PROFILE	AĞIRLIK / Weight 1,655 kg/mt						
<p>20-100141-32</p> <table border="1"> <tr> <td>CAM TUTUCU PROFİL GLASS HOLDER PROFILE</td> <td>AĞIRLIK / Weight 2,518 kg/mt</td> </tr> </table>	CAM TUTUCU PROFİL GLASS HOLDER PROFILE	AĞIRLIK / Weight 2,518 kg/mt		<p>20-109151-22</p> <table border="1"> <tr> <td>KÜPEŞTE ÜST PROFİL TOP RAILING PROFILE</td> <td>AĞIRLIK / Weight 1,851 kg/mt</td> </tr> </table>	KÜPEŞTE ÜST PROFİL TOP RAILING PROFILE	AĞIRLIK / Weight 1,851 kg/mt	
CAM TUTUCU PROFİL GLASS HOLDER PROFILE	AĞIRLIK / Weight 2,518 kg/mt						
KÜPEŞTE ÜST PROFİL TOP RAILING PROFILE	AĞIRLIK / Weight 1,851 kg/mt						
<p>20-730042-20</p> <table border="1"> <tr> <td>CAM TUTUCU PROFİL GLASS HOLDER PROFILE</td> <td>AĞIRLIK / Weight 1,285 kg/mt</td> </tr> </table>	CAM TUTUCU PROFİL GLASS HOLDER PROFILE	AĞIRLIK / Weight 1,285 kg/mt		<p>20-154021-20</p> <table border="1"> <tr> <td>KÜPEŞTE ÜST PROFİL TOP RAILING PROFILE</td> <td>AĞIRLIK / Weight 2,616 kg/mt</td> </tr> </table>	KÜPEŞTE ÜST PROFİL TOP RAILING PROFILE	AĞIRLIK / Weight 2,616 kg/mt	
CAM TUTUCU PROFİL GLASS HOLDER PROFILE	AĞIRLIK / Weight 1,285 kg/mt						
KÜPEŞTE ÜST PROFİL TOP RAILING PROFILE	AĞIRLIK / Weight 2,616 kg/mt						
<p>20-120171-38</p> <table border="1"> <tr> <td>CAM TUTUCU PROFİL GLASS HOLDER PROFILE</td> <td>AĞIRLIK / Weight 5,262 kg/mt</td> </tr> </table>	CAM TUTUCU PROFİL GLASS HOLDER PROFILE	AĞIRLIK / Weight 5,262 kg/mt					
CAM TUTUCU PROFİL GLASS HOLDER PROFILE	AĞIRLIK / Weight 5,262 kg/mt						

PROFİL LİSTESİ - PROFILE LISTS

<p>20-144011-90</p>			<p>20-230490-60</p>		
<p>CAM TUTUCU PROFİL GLASS HOLDER PROFILE</p>	<p>AĞIRLIK / Weight 7,129 kg/mt</p>		<p>CAM TUTUCU PROFİL GLASS HOLDER PROFILE</p>	<p>AĞIRLIK / Weight 6,689 kg/mt</p>	
<p>20-144021-12</p>			<p>20-211170-60</p>		
<p>KAPAK PROFİLİ COVER PROFILE</p>	<p>AĞIRLIK / Weight 0,115 kg/mt</p>		<p>MONTAJ PROFİLİ ASSEMBLY PROFILE</p>	<p>AĞIRLIK / Weight 3,894 kg/mt</p>	
<p>20-104221-70</p>			<p>20-104221-70</p>		
<p>CAM TUTUCU PROFİL GLASS HOLDER PROFILE</p>	<p>AĞIRLIK / Weight 6,075 kg/mt</p>		<p>CAM TUTUCU PROFİL GLASS HOLDER PROFILE</p>	<p>AĞIRLIK / Weight 6,075 kg/mt</p>	

PROFİL LİSTESİ - PROFILE LISTS

20-105021-15			10218		
KAPAK PROFİLİ COVER PROFILE	AĞIRLIK / Weight 0,867 kg/mt		KAPAK PROFİLİ COVER PROFILE	AĞIRLIK / Weight 0,251 kg/mt	
20-610021-15			10219		
KAPAK PROFİLİ COVER PROFILE	AĞIRLIK / Weight 0,361 kg/mt		CAM TUTUCU PROFİL GLASS HOLDER PROFILE	AĞIRLIK / Weight 1,615 kg/mt	
10215					
KÜPEŞTE ÜST PROFİL TOP RAILING PROFILE	AĞIRLIK / Weight 1,202 kg/mt				
10216					
KAPAK PROFİLİ COVER PROFILE	AĞIRLIK / Weight 0,737 kg/mt				
10217					
DİKME PROFİLİ VERTICAL PROFILE	AĞIRLIK / Weight 2,403 kg/mt				
		10217 ANKRAJ			

Profil ağırlıklarımız teorik olup; teslim anındaki tartımız geçerlidir.

PROFİL LİSTESİ - PROFILE LISTS

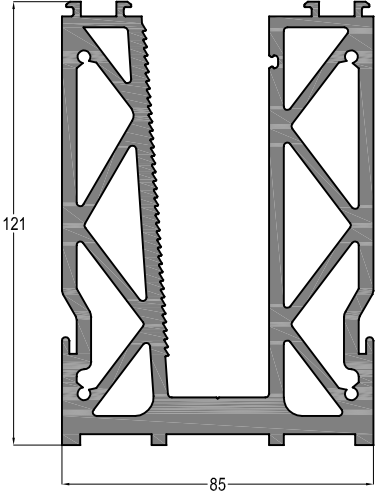
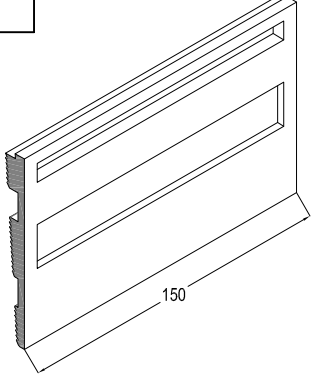
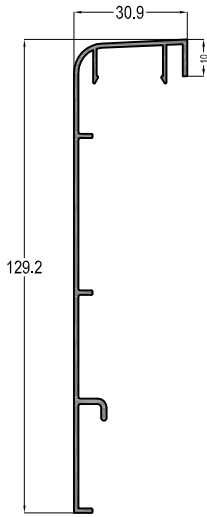
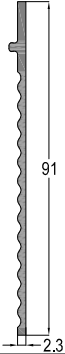
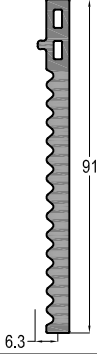
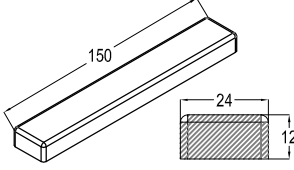
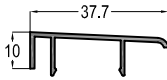
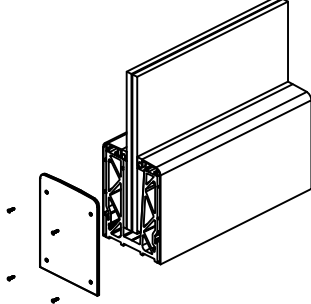
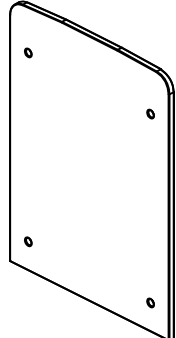
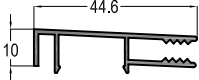
<p>20-2402</p> <p>CAM TUTUCU PROFİL GLASS HOLDER PROFILE</p> <p>AĞIRLIK / Weight 9,207 kg/mt</p>		<p>PVC-01</p> <p>PVC TAKOZ PVC WEDGE</p> 	
<p>20-2510</p> <p>KAPAK PROFİLİ COVER PROFILE</p> <p>AĞIRLIK / Weight 0,667 kg/mt</p>			
		<p>PVC-02</p> <p>PVC TAKOZ PVC WEDGE</p> 	
<p>20-2507</p> <p>KAPAK PROFİLİ COVER PROFILE</p> <p>AĞIRLIK / Weight 0,208 kg/mt</p>		<p>KPK-01</p> <p>KAPAK COVER</p> 	
<p>20-2508</p> <p>KAPAK PROFİLİ COVER PROFILE</p> <p>AĞIRLIK / Weight 0,308 kg/mt</p>			

Profil ağırlıklarımız teorik olup; teslim anındaki tartımız geçerlidir.

DETAY - DETAIL

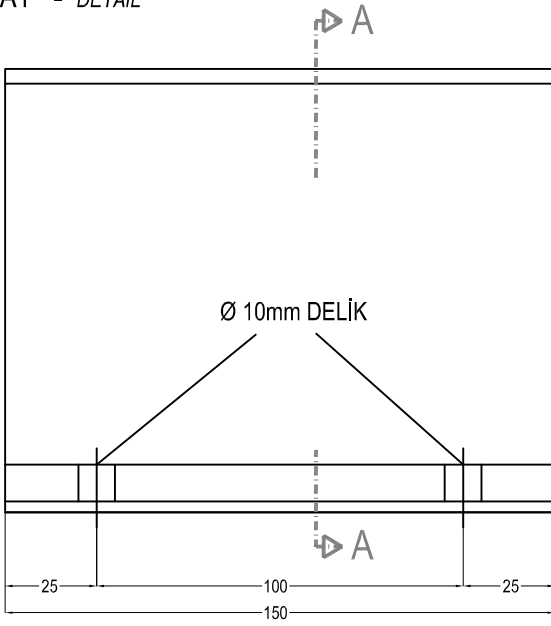

Görünüş

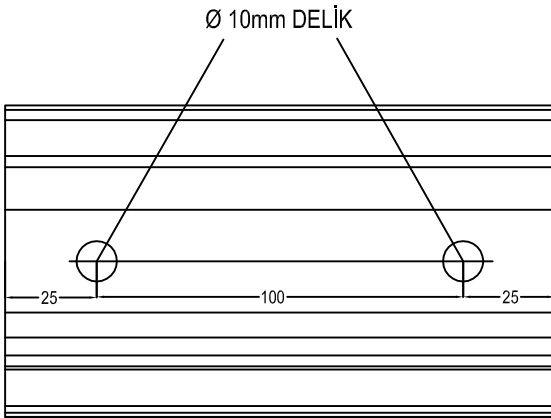

Üst Görünüş

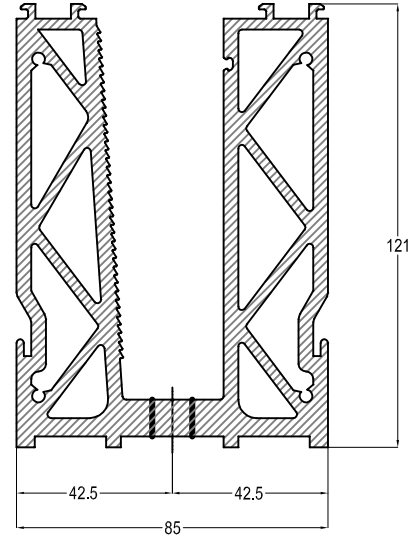

A - A KESİTİ

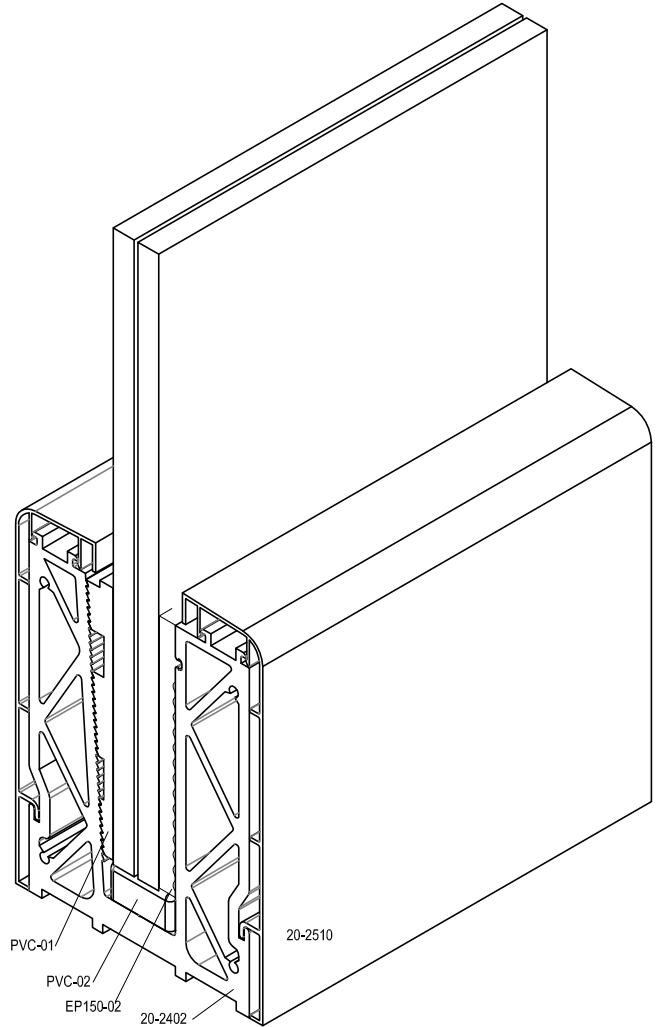

DETAY - DETAIL

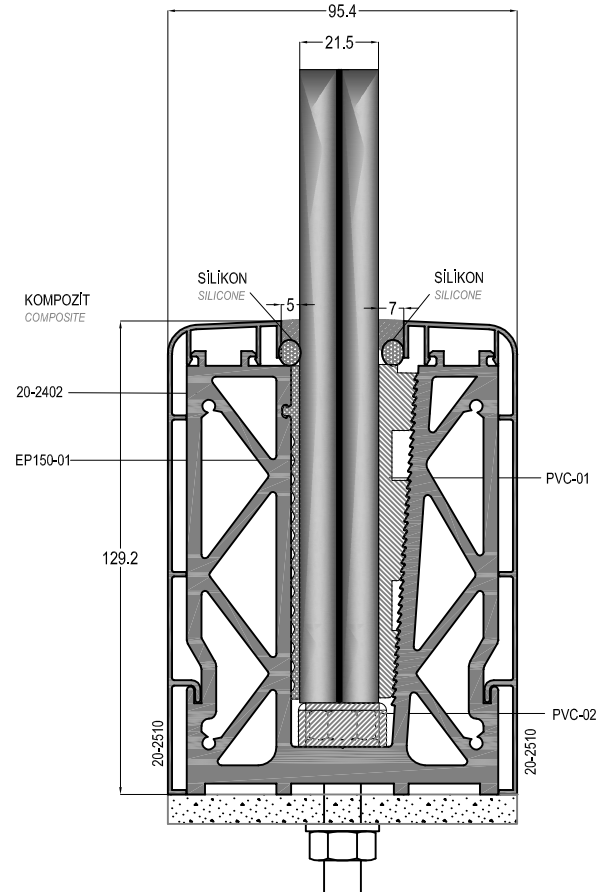
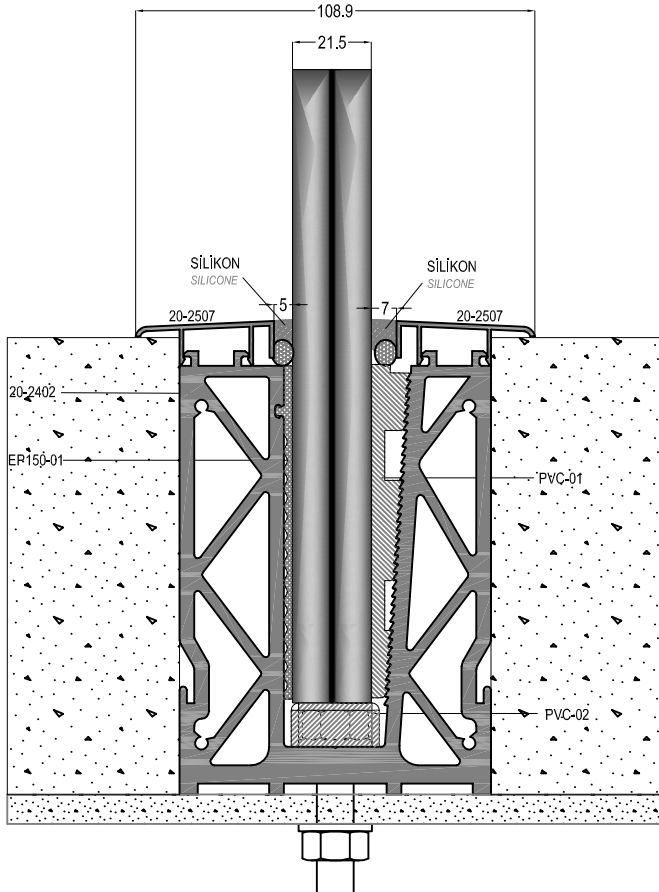
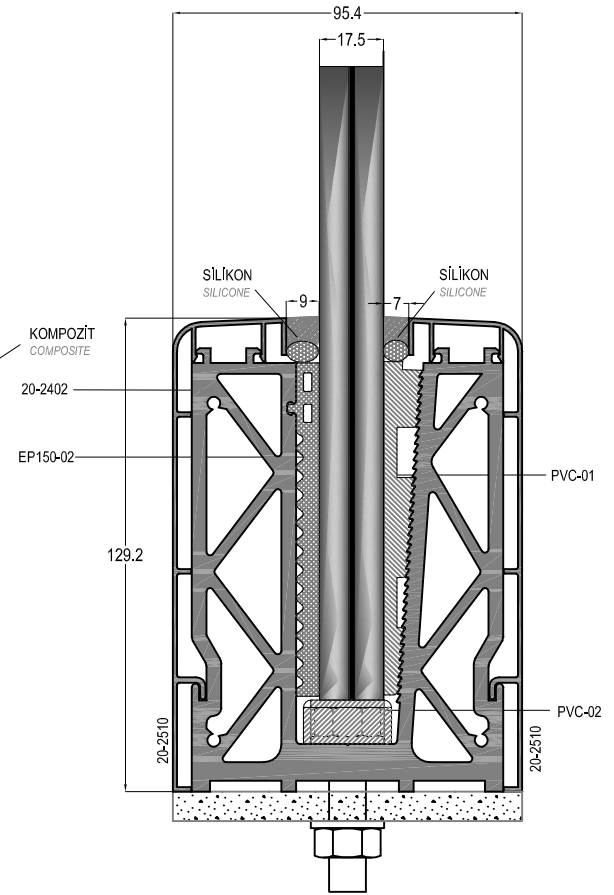
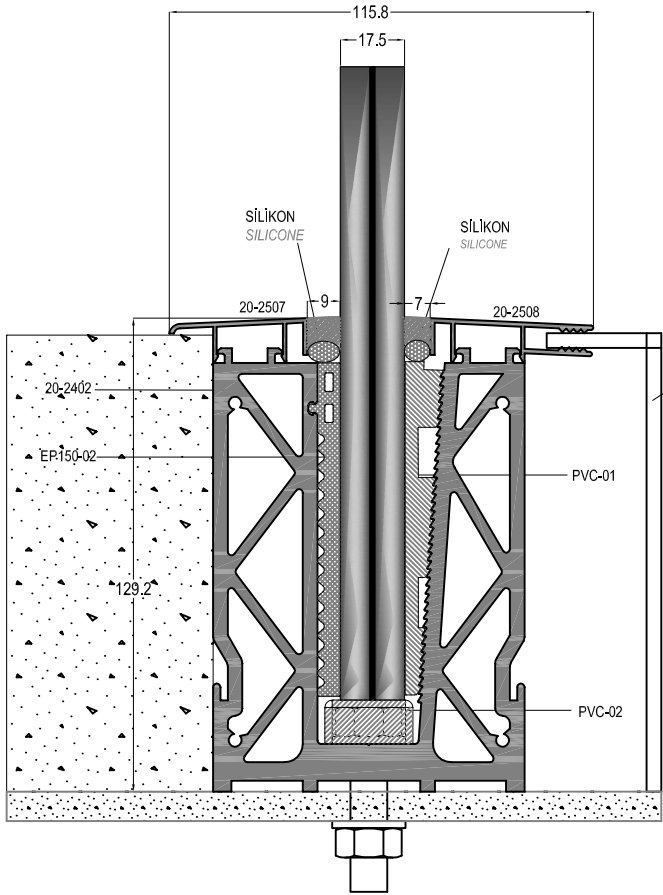

Fabrika / Factory

Adres: Organize San. Bölg.
No: 2, Cad.2 Kırklareli / Türkiye
Tel : 0288 263 44 15
Fax : 0288 263 43 36

Çorlu – Genel Merkez / Head Office

Adres: Hatip Mah.
Ali Osman Çelebi Bulvarı No:54
Çorlu / Tekirdağ / Türkiye
Tel : 0282 652 50 96
Fax : 0282 652 56 76

İstanbul- Bölge Müdürlüğü / District Office

Adres: Prof.Dr.Nevzat Pisak Cad.
Doğu Sanayi Sitesi 8.Blok No:3
Yenibosna / İstanbul / Türkiye
Tel : 0212 654 65 23 / 0212 654 65 24
Fax : 0212 654 65 26

İzmir – Ege Bölge Müdürlüğü / District Office

Adres: 1561 Sok. No:50
Çınarlı / İzmir / Türkiye
Tel : 0232 461 93 14 / 461 60 63
Fax : 0232 461 84 03

Sofya Ofis / Sofia Office

A: 38 Kapitan Dimitar Spisarevski Street
Res.w. Druzhba 1,
Sofia 1592 Bulgaria (Bulgaristan)
Tel : 00359 2 444 00 62
00359 889 170 062
E-mail : office@asistal.bg